

MANIGLIA FISSA CON BOCCOLA OTTONE FILETTATA

HANDLE, FIXED, THREADED BRASS INSERT

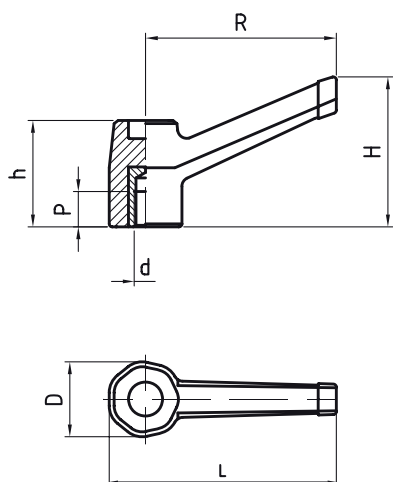

- » **Tecnopolimero** rinforzato con fibra di vetro, colore standard nero, resistente a solventi, oli e grassi.
- » **Boccola** in ottone con foro cieco filettato.
- » **Mostrina** frontale autoadesiva in alluminio anodizzato opaco.
- » Disponibile a richiesta con inserto in ACCIAIO ZINCATO e altri colori (vedi pag. 5).
- » Technopolymer, fiberglass-reinforced, black colour, solvents-oils-greaseproof.
- » Brass insert, with threaded blind hole.
- » Anodized aluminium self-adhesive frontal cover.
- » ZINC-PLATED insert and colours available on request (see page 5).

Cod. Code	R	L	H	D	h	d	P	Gr.
14980050	40	50	33	17	22	M05	10	9
14980100	40	50	33	17	22	M06	12	9
14980250	60	70	38	22	26	M06	12	16
14980300	60	70	38	22	26	M08	16	18
14980400	80	95	50	27	33	M10	22	36
14980450	80	95	50	27	33	M12	22	39
14980550	100	117	73	38	42	M14	22	77
14980600	100	117	73	38	42	M16	22	88

MANIGLIA FISSA CON PERNO FERRO

HANDLE, FIXED, STEEL INSERT

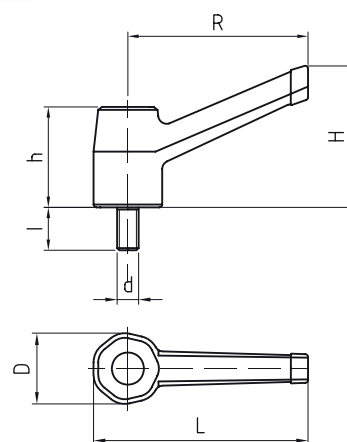

- » **Tecnopolimero** rinforzato con fibra di vetro, colore standard nero, resistente a solventi, oli e grassi.
- » **Perno** in acciaio zincato filettato.
- » **Mostrina** frontale autoadesiva in alluminio anodizzato opaco.
- » Disponibile a richiesta con inserto in OTTONE e INOX e altri colori (vedi pag. 5).
- » Technopolymer, fiberglass-reinforced, black colour, solvents-oils-greaseproof.
- » Zinc-plated, threaded steel stud.
- » Anodized aluminium self-adhesive frontal cover.
- » BRASS and STAINLESS STEEL insert and colours available on request (see page 5).

Cod. Code	R	L	H	D	h	d	l	Gr.
14990050	40	50	33	17	22	M05	20	12
14990200	40	50	33	17	22	M06	20	14
14990500	60	70	38	22	26	M06	30	20
14990750	60	70	38	22	26	M08	30	25
14991300	80	95	50	27	33	M10	30	64
14991550	80	95	50	27	33	M12	30	72
14991950	100	117	73	38	42	M14	40	127
14992150	100	117	73	38	42	M16	50	155